

# IndyTab

# Rev.B

**01. Table of Contents**

**02. Main**

**03. 7-Segment**

U\_IndyTab



IndyTab\_Rev.B [Main].SchDoc

Date	Sch Rev.	PCB Rev.	Change Components	Remark
20.01.28	Rev.D	Rev.D		First Draft

Title : <b>Table of Contents</b>			Cannot open file E:\Chals Work\뉴로메카 문서\Neuromeka_CI_ty
Size : A4	Design Date : 20/04/07	Design By : Park Su Chul	
Sheet : 1 of 9	Redesign Date : *	Redesign By : *	
Revision : D	File : IndyTab_Rev.B.SchDoc		

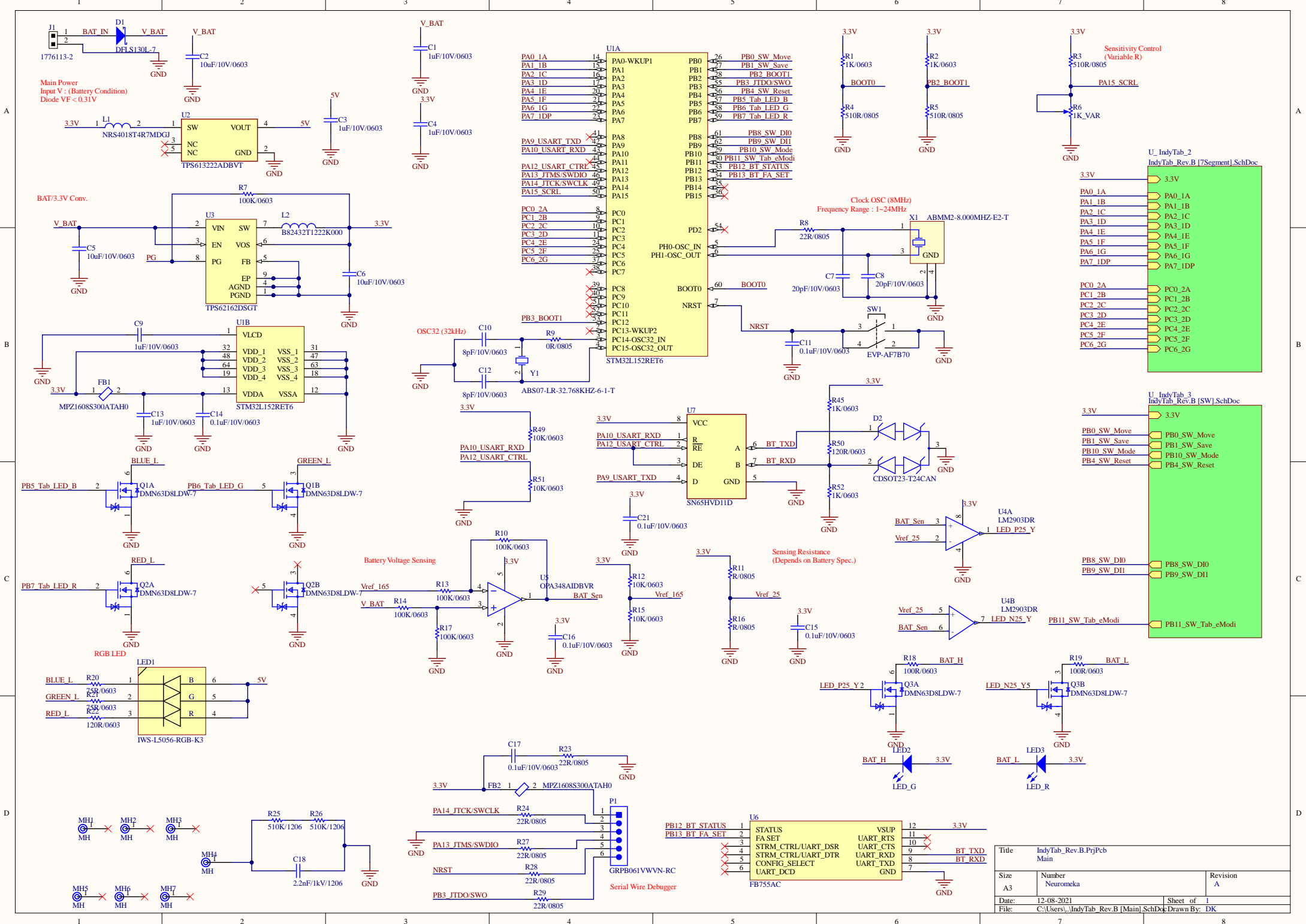

Title		IndyTab_Rev.B.PrjPcb	
Main			
Size	A3	Number	Neuromeka
Date:	12-08-2021	Sheet of	1
File:	C:\Users\...IndyTab_Rev.B [Main].SchDoc	Drawn By:	DK

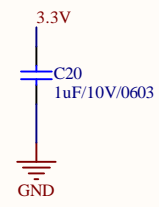
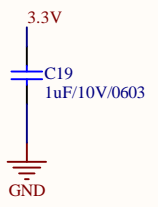
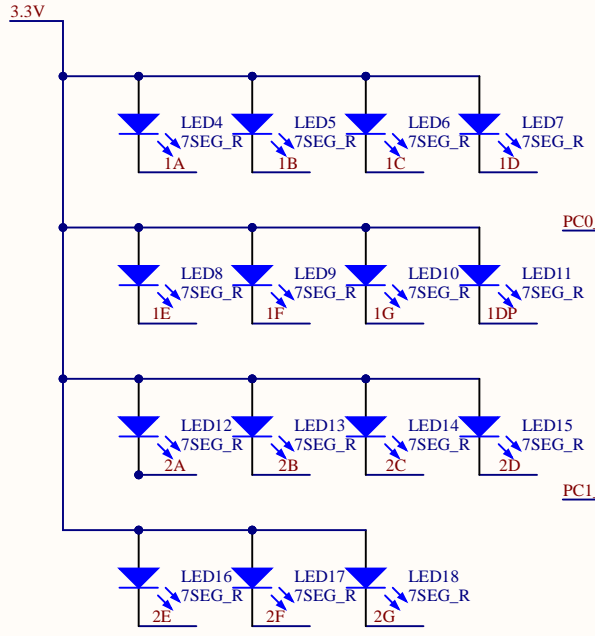
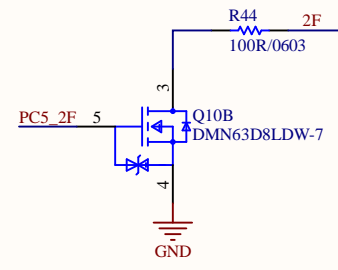
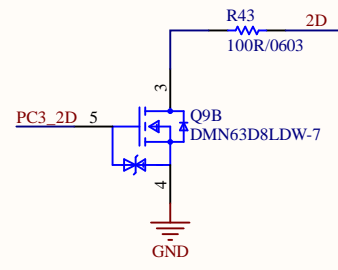
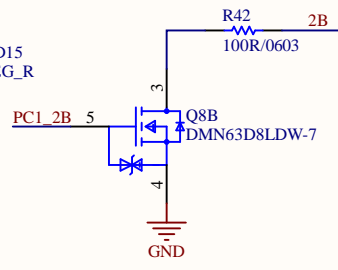
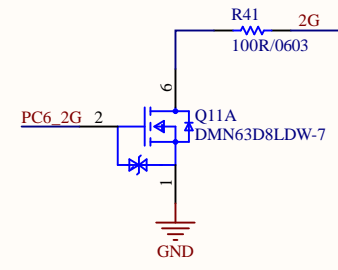
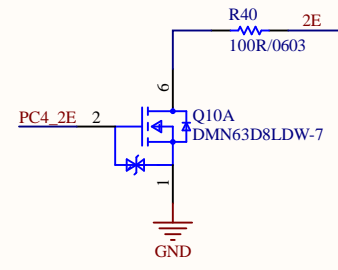
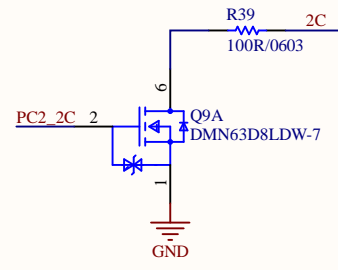
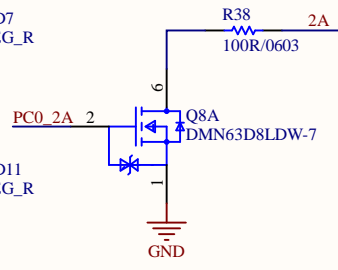
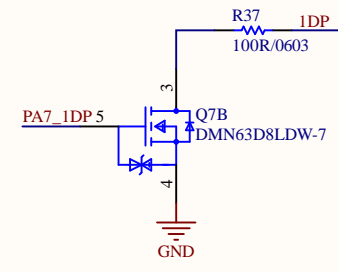
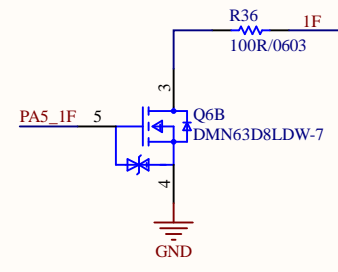
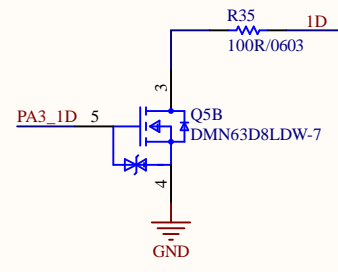
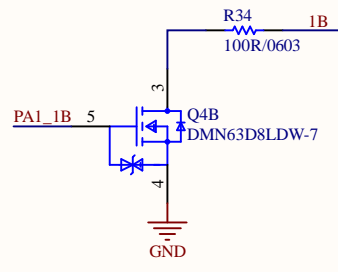
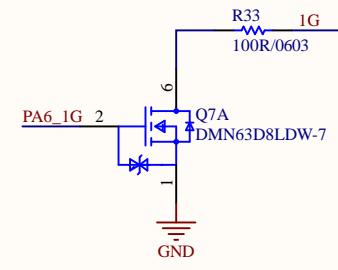
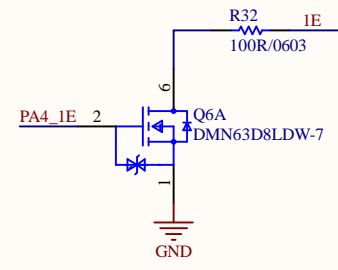
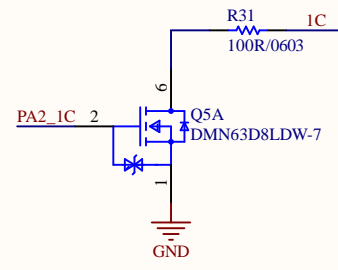
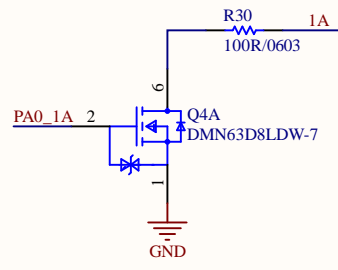
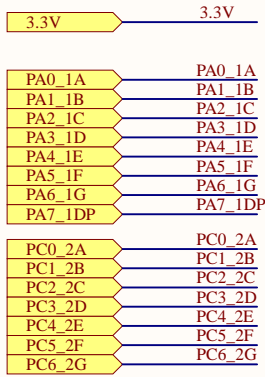

Title			IndyTab_Rev.B.PrjPcb
Size			A4
Number		*	
Revision		*	
Date:	12-08-2021	Sheet of	*
File:	C:\Users\...\IndyTab_Rev.B [7Segment].Sch	Drawn By:	*

3.3V

PB0\_SW\_Move  
PB1\_SW\_Save  
PB10\_SW\_Mode  
PB4\_SW\_Reset

PB8\_SW\_DI0  
PB9\_SW\_DI1

PB11\_SW\_Tab\_eModi

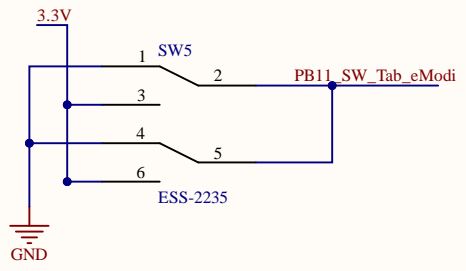
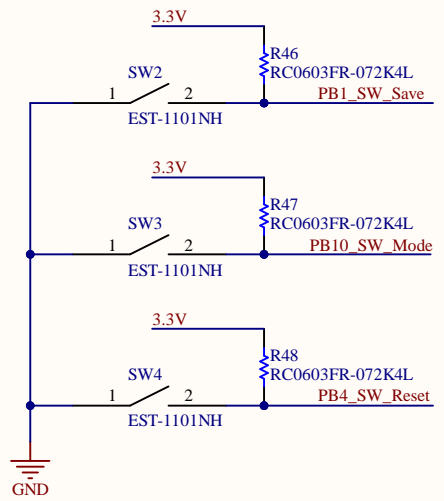
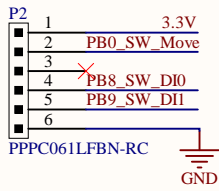

Title		
Size	Number	Revision
A4		
Date:	12-08-2021	Sheet of
File:	C:\Users\...\IndyTab_Rev.B [SW].SchDoc	Drawn By: