

Decoupling

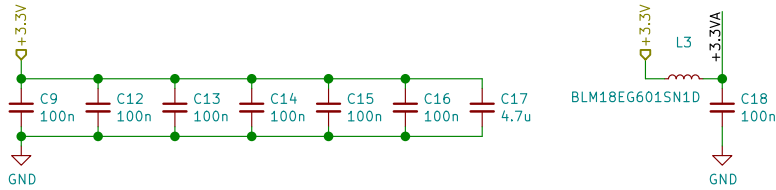

LSE

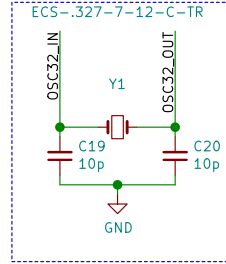

HSE

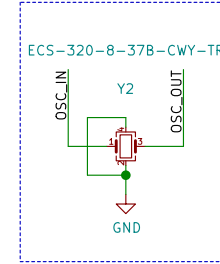

SWD

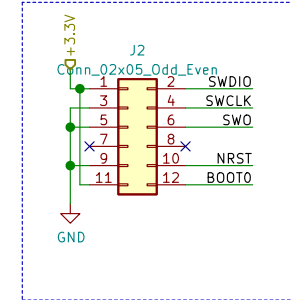

STM32WB MCU

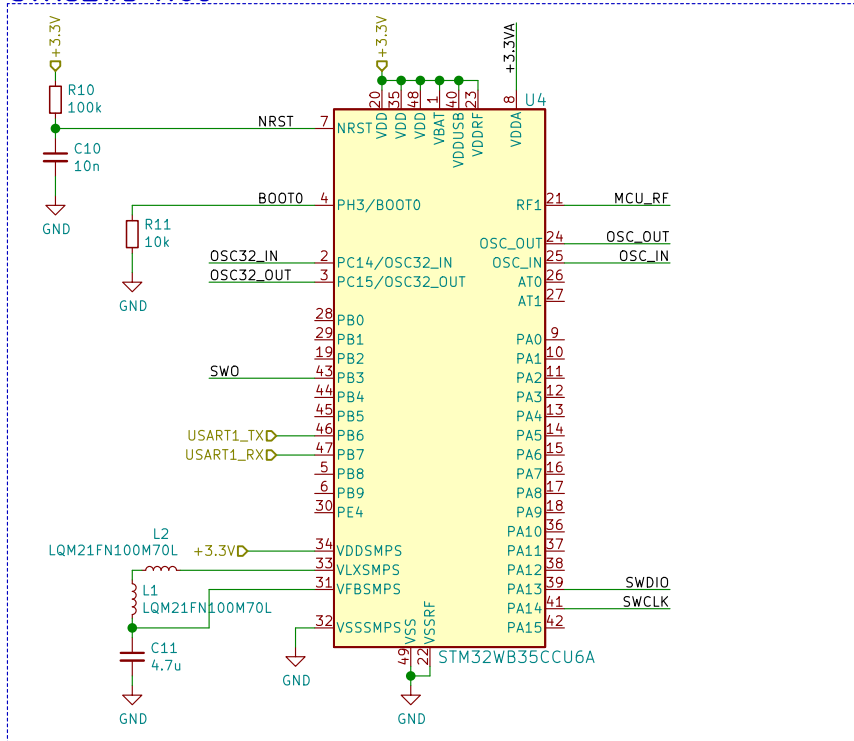

2.4GHz Antenna

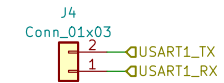
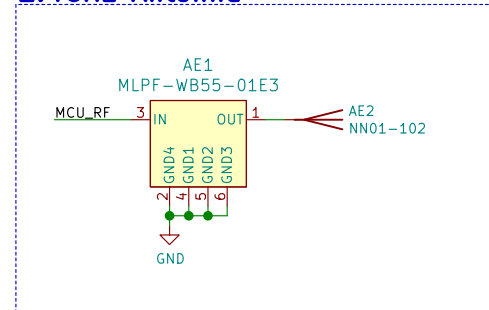

Sheet: /
File: MCU.sch

Title: Project

Size: A4 Date:
KiCad E.D.A. eeschema (5.1.7)-1

Rev:
Id: 1/1