

系统供电稳压

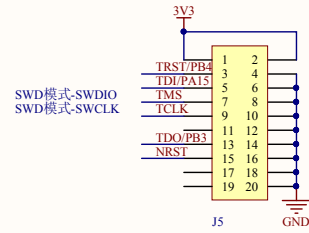

调试JTAG、SWD接口

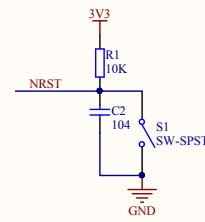

系统复位

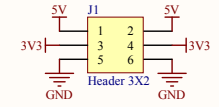

扩展供电接口

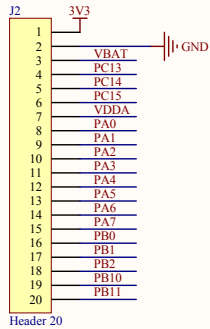

Header 20

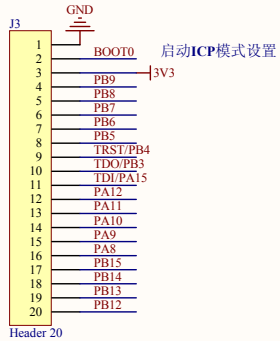

Header 20

通用I/O接口

CPU系统

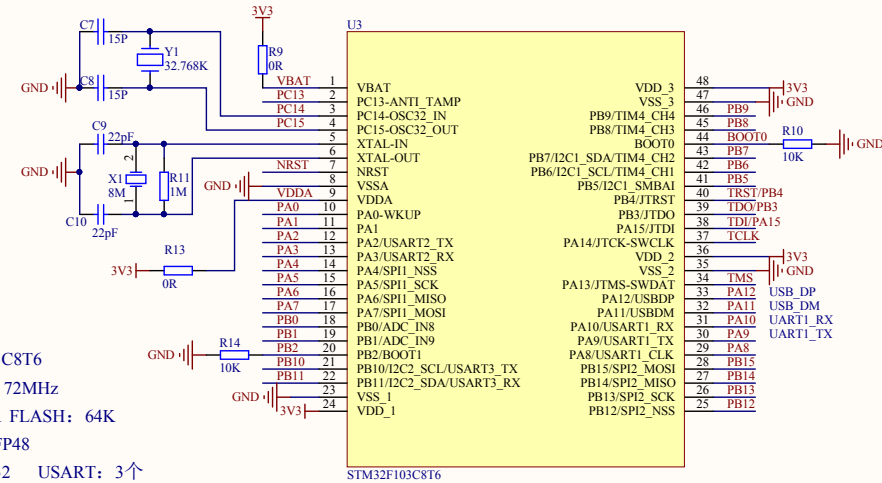

CPU简介

STM32F103C8T6

CPU频率：72MHz

RAM：20K FLASH：64K

封装：LQFP48

通用I/O：32 USART：3个

SPI：2个 USB：1个

CAN：1个 IIC：2个

12位同步ADC：2组 10通道

工作电压：2.0至3.6V

具体详细功能分配请以数据手册为准

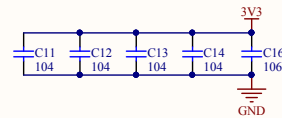

E2数据存储

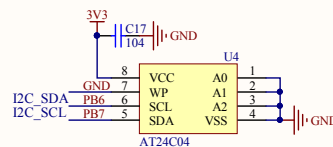

E2数据存储

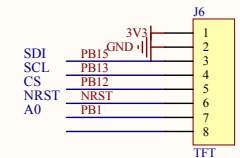

OLED液晶接口

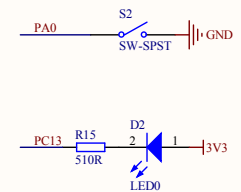

按键和LED灯

供电及STM32-USB Slave

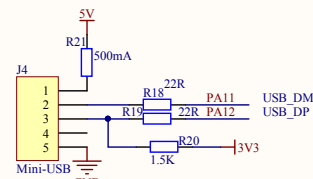

供电及STM32-USB Slave

Title		
Size	Number	Revision
A3		
Date:	2014-11-24	Sheet of
File:	C:\Documents and Settings\STM32	Sheet of

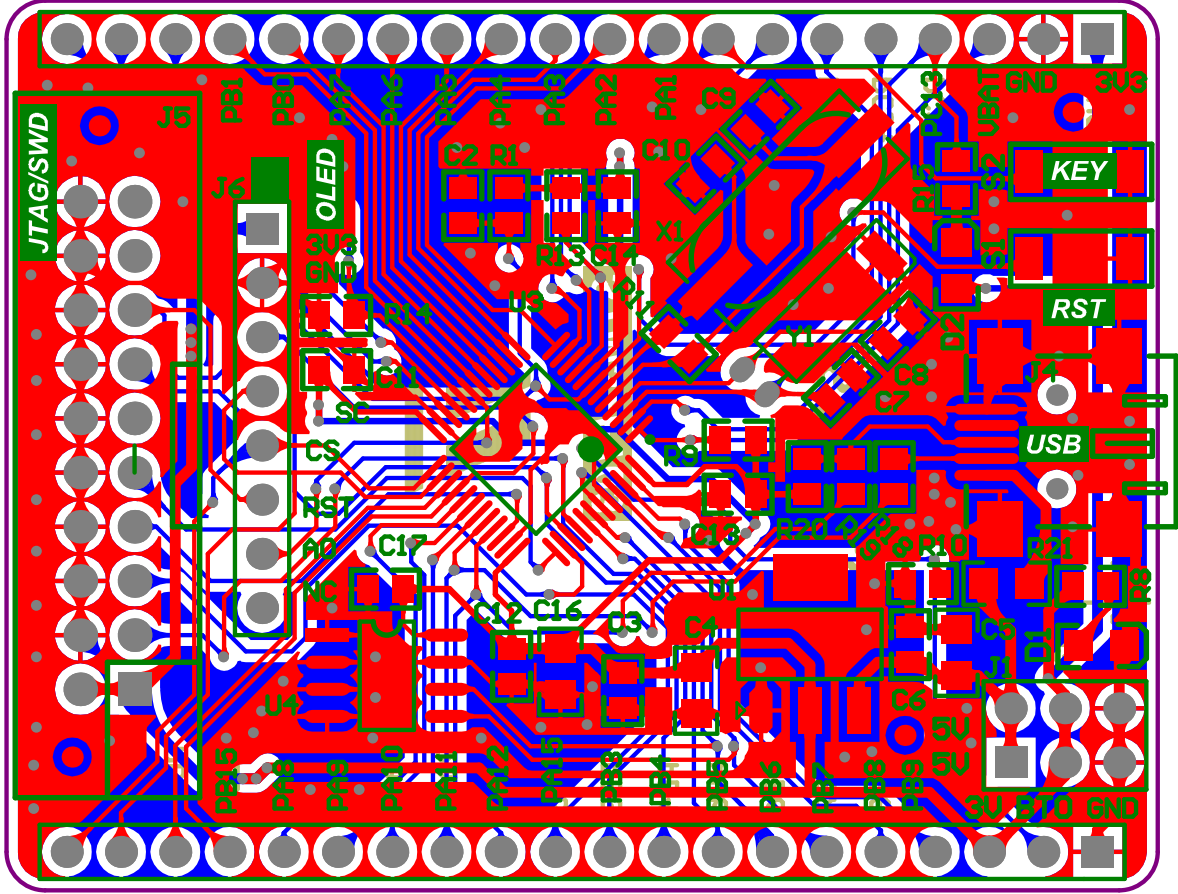

Comment	Description	Designator	Footprint	LibRef	Quantity
104	Capacitor	C2, C3, C6, C11, C12, C13, C14, C17	RC0603	CAP1, Cap, CAP, CAP1, CAP1, CAP1, CAP1, Cap	8
10uF	Capacitor, [NoValue]	C4, C5	RC0805	CAPACITOR POL, ELECTRO2	2
15P		C7, C8	RC0603	CAP	2
22pF	Capacitor	C9, C10	RC0603	CAP1	2
106	Capacitor	C16	RC0805	CAP1	1
LED0	Typical INFRARED GaAs LED	D1, D2	LED0805	LED0	2
Header 3X2	Header, 3-Pin, Dual row	J1	IDE3X2-2.54	Header 3X2	1
Header 20	Header, 20-Pin	J2, J3	HDR1X20	Header 20	2
Mini-USB	Header, 5-Pin	J4	mini_USB	Header 5	1
	Header, 10-Pin, Dual row, Right Angle	J5	JTAG20P	Header 10X2H	1
TFT	Header, 8-Pin	J6	HDR1X8	Header 8	1
10K		R1, R10, R14	RC0603	R	3
510R		R8, R15	RC0603	R	2
0R		R9, R13	RC0603	R	2
1M		R11	RC0603	R	1
22R	Resistor	R18, R19	RC0603	Res2	2
1.5K	Resistor	R20	RC0603	Res2	1
500mA	Resistor	R21	RC0805	Res2	1
SW-SPST	Single-Pole, Single-Throw Switch	S1, S2	SMT-KEY	SW-SPST	2
AMS1117-3.3		U1	SOT223	LT1085CM-3.3	1
STM32F103C8T6		U3	LQFP48	STM32F103C8T6	1
AT24C04		U4	SOIC-8P	EPROM	1
8M	Crystal Oscillator	X1	SMD49S	XTAL_SMD	1
32.768K	晶振	Y1	JZ32768	CRYSTAL	1